

L.GLN/L  
 Befestigungsart:  
 Asphalt  
 Rasen  
 Kies  
 Splitt  
 Schotter  
 R8 Hundsbort

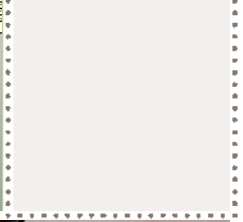

Architecture  
 Construction  
 Design GmbH  
 A C D

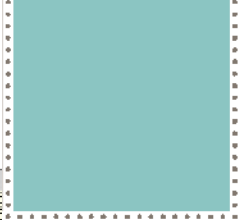

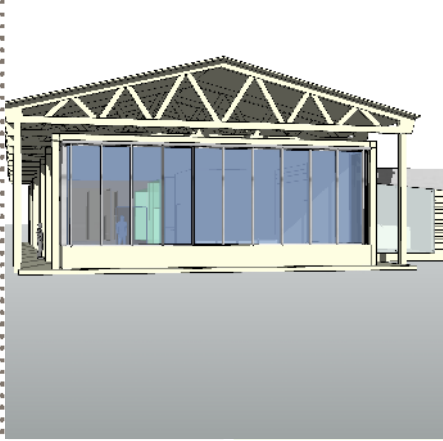
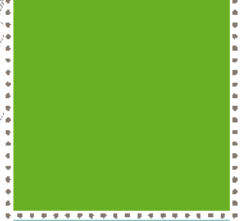
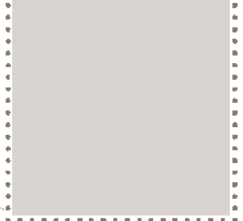
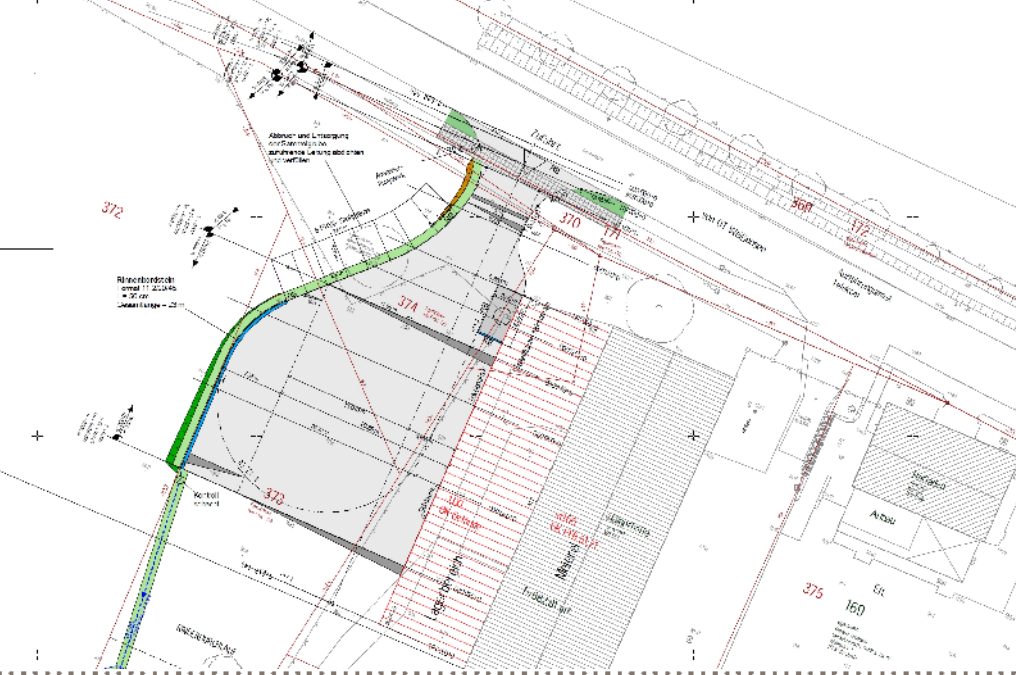
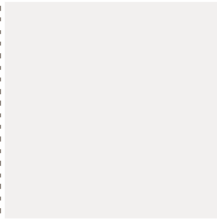
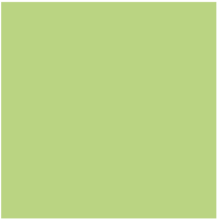
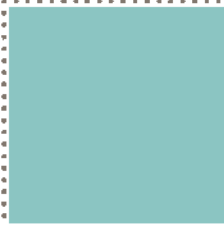
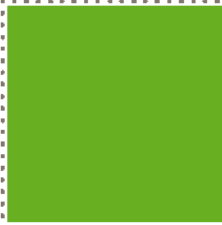
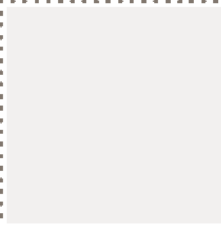
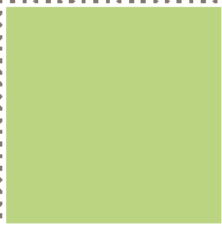
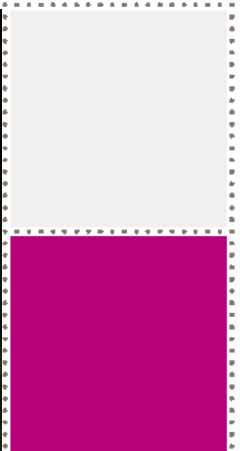
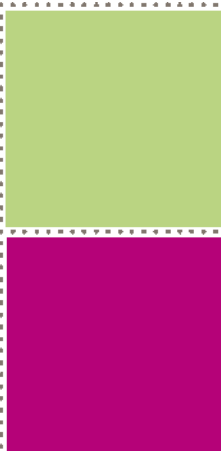
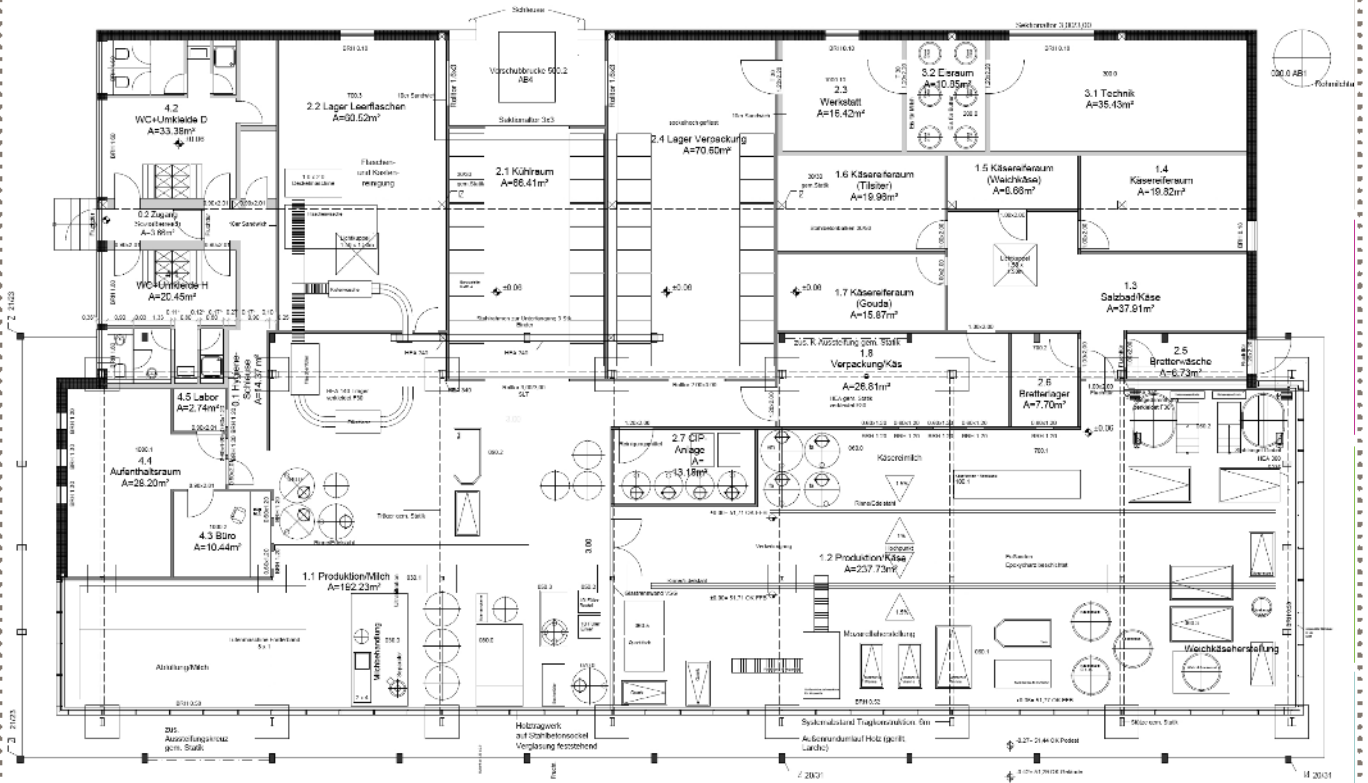
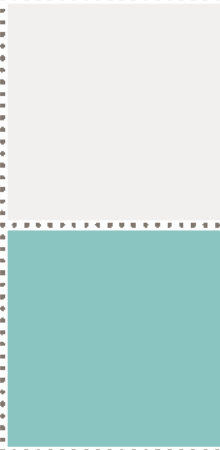
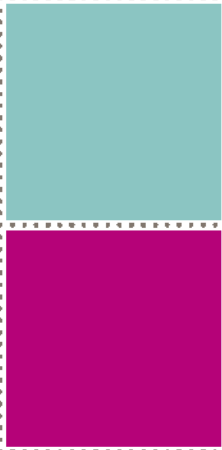



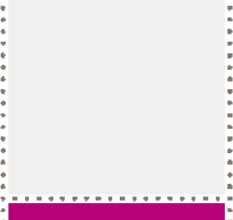
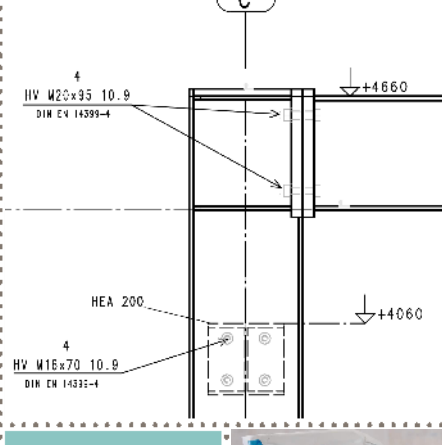
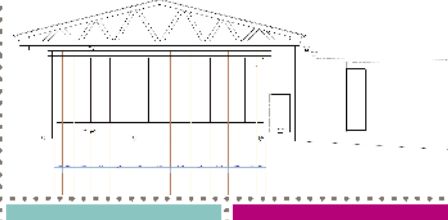
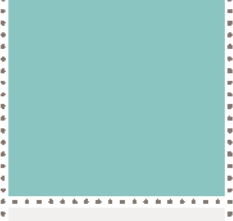
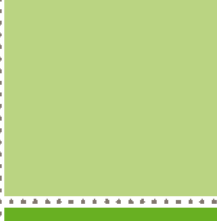
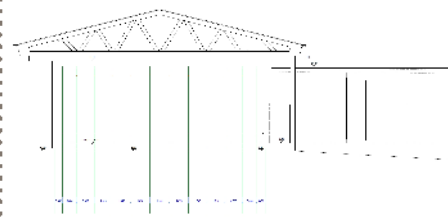
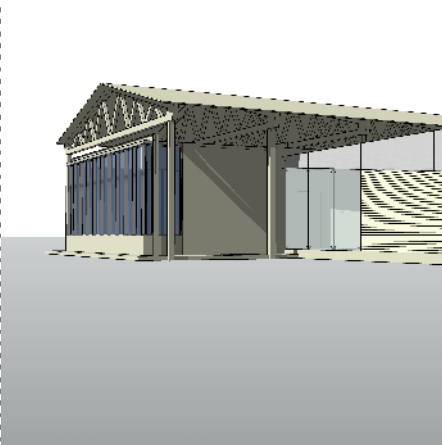
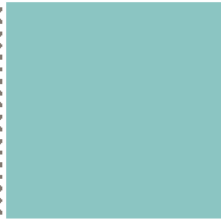
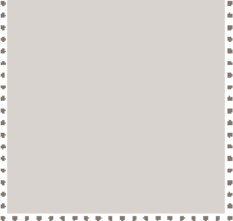
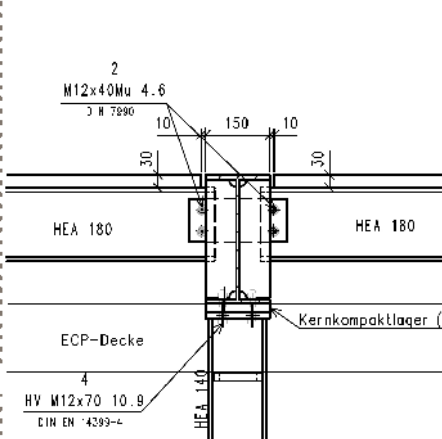
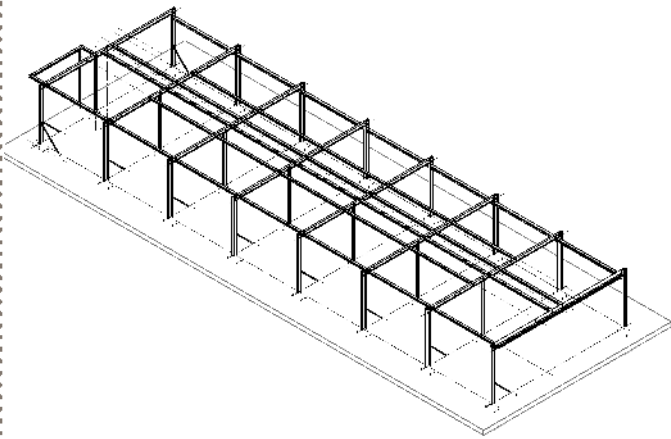
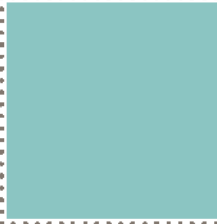
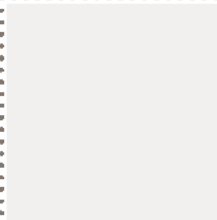

Architecture  
Construction  
Design GmbH  
A C D

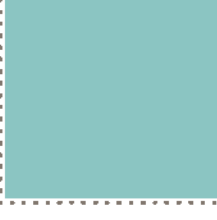
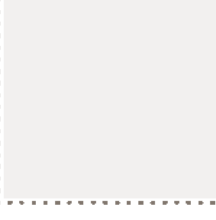
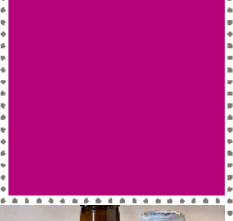
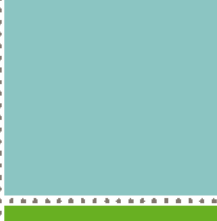
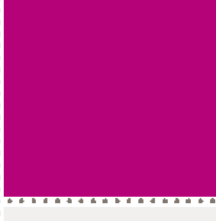

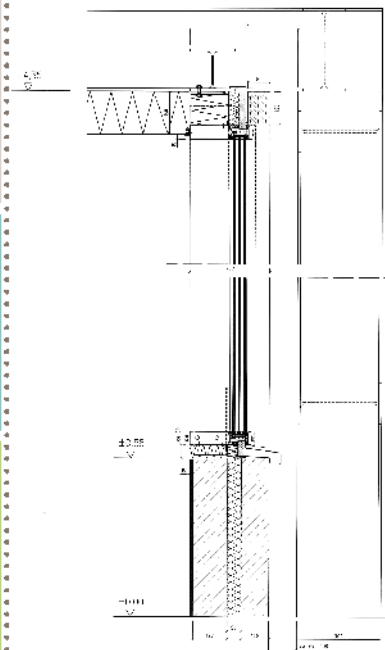
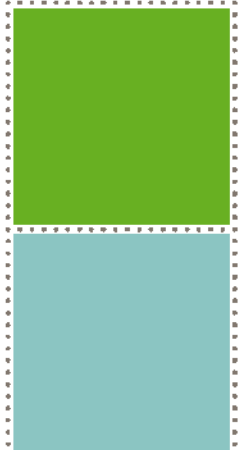
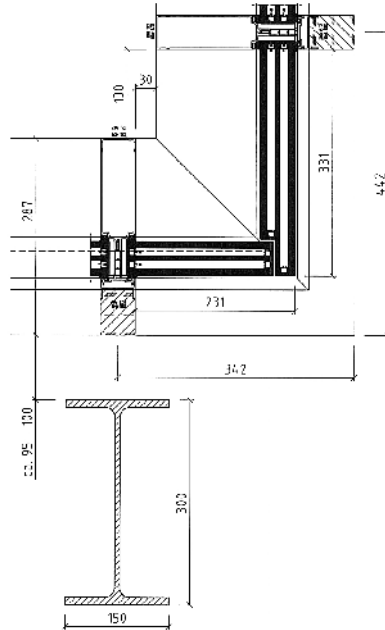
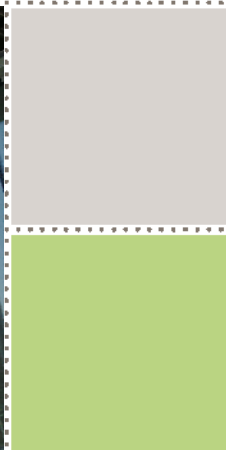
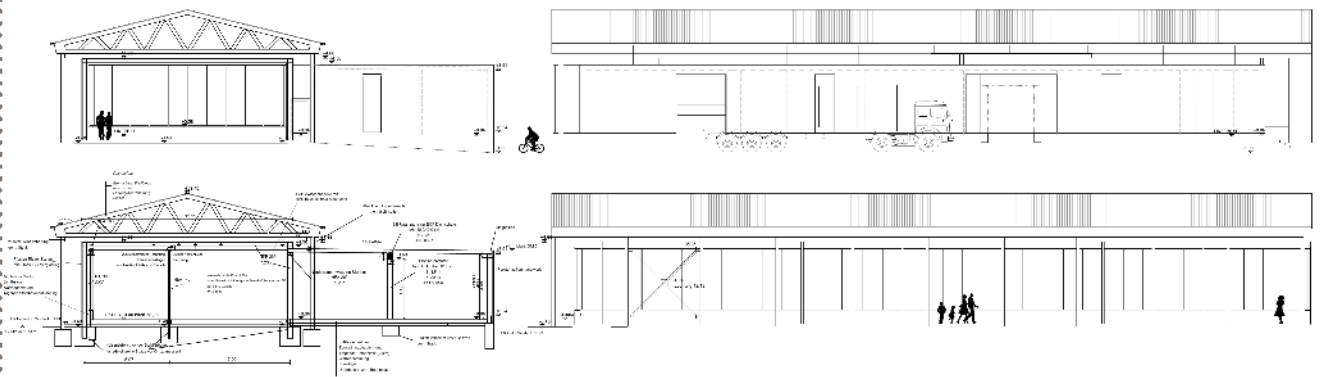
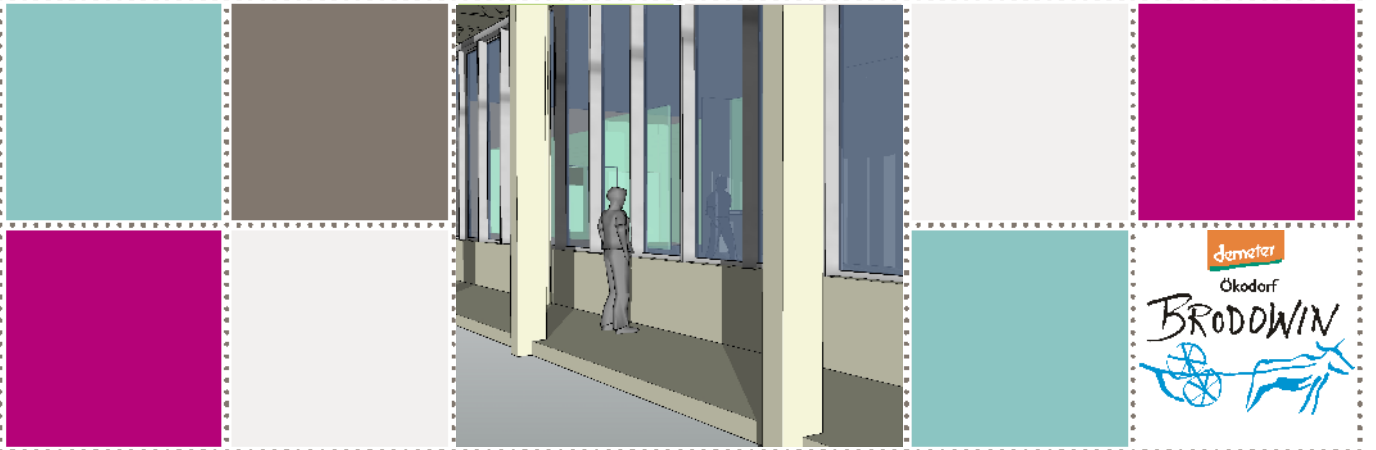

Architecture  
Construction  
Design GmbH  
A C D

Unter Verwendung von Fachplanermaterial:  
ingenieurbüro Lenzel  
Dipl.-Ing. Rüdiger Rötterschne  
Pascal Böhler  
Rüger Glas Bau  
Plattenhardt und Mörch

